

RELIURE ET JONC DE PROTECTION

*matière usuelle
PVC SEMI-RIGIDE
OU SOUPLE*

*sur mesure
DEMANDEZ
VOTRE LONGUEUR
DE DÉCOUPE*

COULEURS
DISPONIBLES

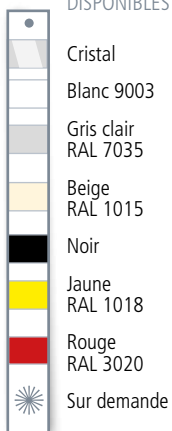

OPTION
DISPONIBLE



Couleur
à la demande

Référence produit	Cotes			Minimum commande
	(a)	(b)	(c)	
Jonc de protection				
0098a	2 mm	4 mm		500 ml
0098b	2,3 mm	4,6 mm		500 ml
0111	2 mm	5 mm	3,2 mm	500 ml
0129	2 mm	7 mm	5 mm	500 ml
0264	8 mm	6 mm	3,5 mm	500 ml



réf. 0098



réf. 0111/0129/0264

échelle
1/1

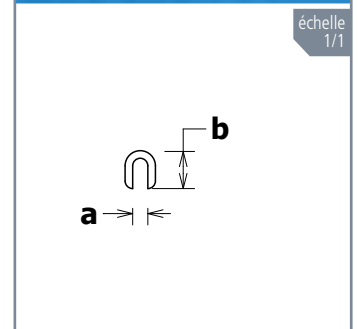
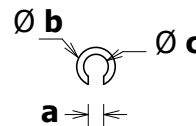

échelle
1/1

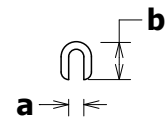

BORDURE SOUPLE

Référence produit	Minimum commande
Bordure souple	
N101	1000 ml conditionnement sur rouleaux
N134	
N241	
N133	

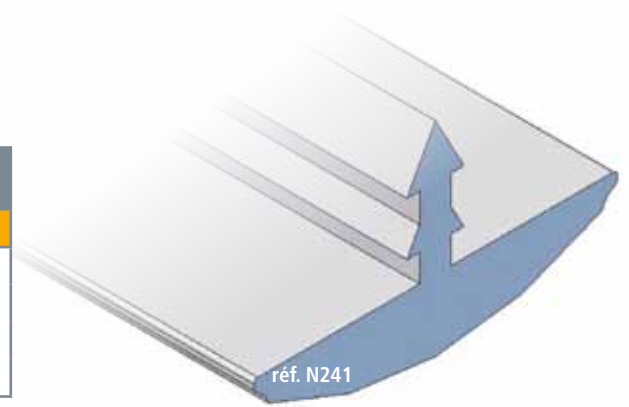

réf. N241

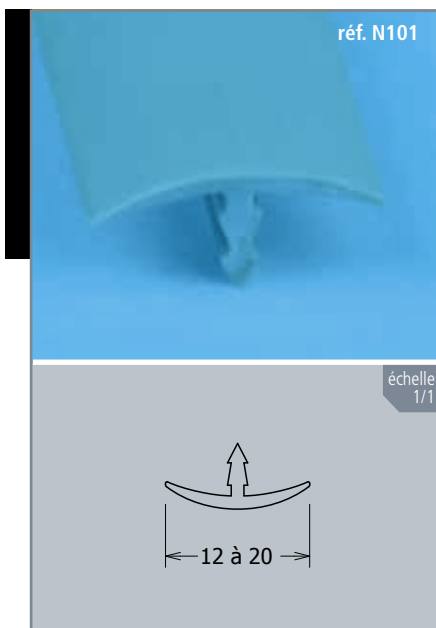

réf. N101

échelle
1/1

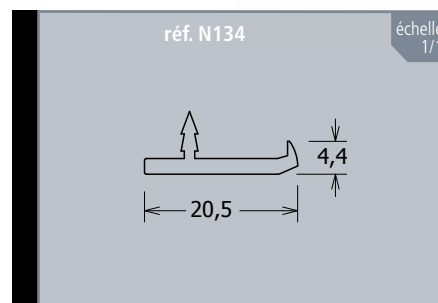
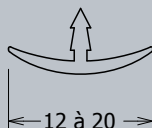

réf. N134

échelle
1/1

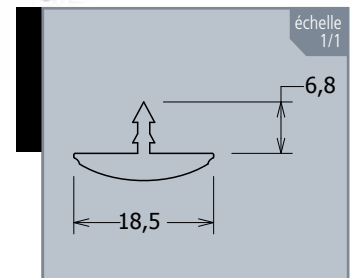
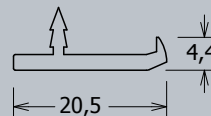

échelle
1/1

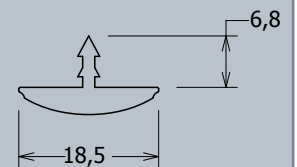

réf. N133/N134

échelle
1/1

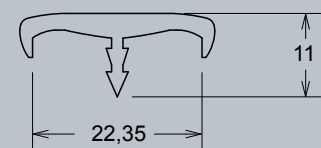

réf. N133